

MACHO SOLDAR
WELDING MALE
NEZ À SOUDER

FIG.1011

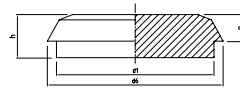

CASQUILLO CIEGO DIN
BLIND LINER DIN
BOUCHON DIN

FIG.1032

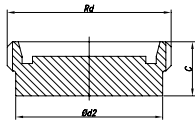

MACHO CIEGO
BLIND MALE
NEZ BOUCHON

FIG.1031

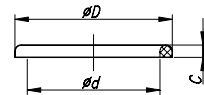

JUNTA RACORD
UNION SEAL
JOINT RACCORD

FIG.1008

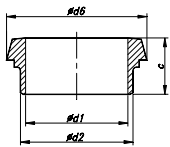

CASQUILLO SOLDAR
WELDING LINER
DOUILLE À SOUDER

FIG.1012

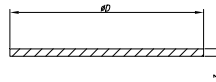

JUNTA PLANA TUERCA CIEGA
NUT SEAL
JOINT PLAT ECROU BOUCH.

FIG.1029

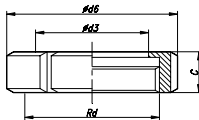

TUERCA
NUT
ECROU

FIG.1003

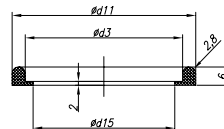

JUNTA RACORD CON LABIO
UNION SEAL WITH LIP
JOINT RACCORD AVEC LÈVRE

FIG.1008L

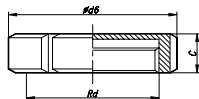

TUERCA CIEGA
BLIND NUT
ECROU BOUCHON

FIG.1023

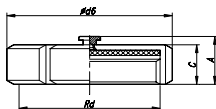

TUERCA CIEGA CON PIVOTE
BLIND NUT WITH BOSS
ECROU BOUC. AVEC PIVOT

FIG.1024

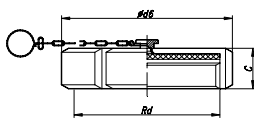

TUERCA CIEGA COMPLETA
BLIND NUT COMPLET
ECROU BOUCHON AVEC
PIVOT ET CHAINETTE

FIG.1025

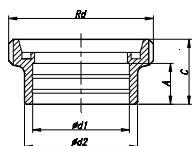

MACHO MANDRINAR
EXPANDING MALE
NEZ FILETE À DUDGEONNER

FIG.1001

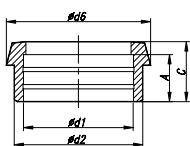

CASQUILLO MANDRINAR
EXPANDING LINER
DOUILLE À DUDGEONNER

FIG.1002

MACHO SOLDAR
 WELDING UNION
 RACCORD A SOUDER

DN	d1	d2	Rd	C	AISI 304L	AISI 316L
10	10	15	28x1/8"	21	1011011	21011011
15	16	21	34x1/8"	21	1011016	21011016
20	20	25	44x1/6"	24	1011021	21011021
25	26	31	52x1/6"	29	1011026	21011026
32	32	37	58x1/6"	32	1011033	21011033
40	38	43	65x1/6"	33	1011041	21011041
50	50	55	78x1/6"	35	1011051	21011051
65	66	72	95x1/6"	40	1011066	21011066
80	81	87	110x1/4"	45	1011081	21011081
100	100	106	130x1/4"	54	1011101	21011101
125	125	132	160x1/4"	46	1011125	21011125
150	150	157	190x1/4"	50	1011150	21011150

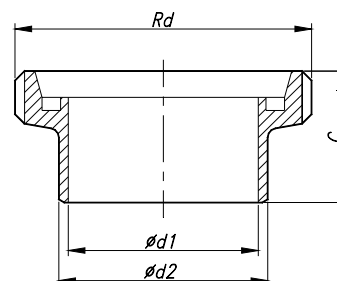

Fig.1011

MACHO CIEGO
 BLIND MALE
 NEZ BOUCHON

DN	d2	Rd	C	AISI 316L
25	44	52x1/6"	23	21031025
32	50	58x1/6"	23	21031032
40	58	65x1/6"	23	21031040
50	70	78x1/6"	26	21031050
65	88	95x1/6"	28	21031065
80	100	110x1/4"	35	21031080
100	120	130x1/4"	35	21031100

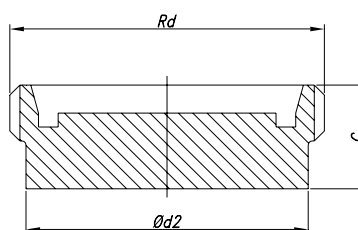

Fig.1031

CASQUILLO SOLDAR
WELDING LINER
DOUILLE À SOUDER

DN	d1	d2	d6	C	AISI 304L	AISI 316L
10	10	15	22,5	17	1012011	21012011
15	16	21	28,5	17	1012016	21012016
20	20	25	36,5	18	1012021	21012021
25	26	31	44	22	1012026	21012026
32	32	37	50	25	1012033	21012033
40	38	43	56	26	1012041	21012041
50	50	55	68,5	28	1012051	21012051
65	66	72	86	32	1012066	21012066
80	81	87	100	37	1012081	21012081
100	100	106	121	44	1012101	21012101
125	125	132	150	34	1012125	21012125
150	150	157	176	37	1012150	21012150

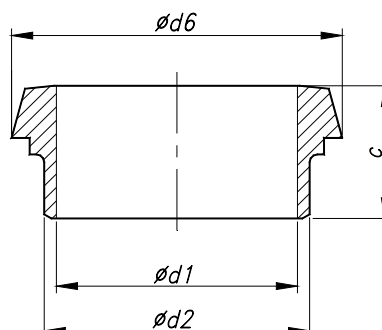

Fig.1012

TUERCA
NUT
ECROU

DN	d3	d6	Rd	C	AISI 304L
10	19	38	28x1/8"	18	1003010
15	25	44	34x1/8"	18	1003015
20	31	54	44x1/6"	20	1003020
25	36	63	52x1/6"	21	1003025
32	42	70	58x1/6"	21	1003032
40	49	78	65x1/6"	21	1003040
50	62	92	78x1/6"	22	1003050
65	80	112	95x1/6"	25	1003065
80	94	127	110x1/4"	29	1003080
100	115	148	130x1/4"	31	1003100
125	138	178	160x1/4"	35	1003125
150	164	210	190x1/4"	40	1003150

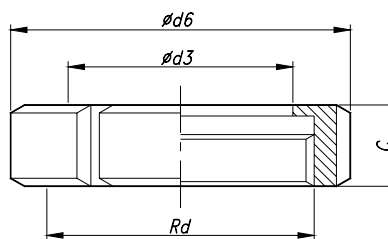

Fig.1003

TUERCA CIEGA
BLIND NUT
ECROU BOUCHON

DN	d6	Rd	C	AISI 304L
10	38	28x1/8"	18	1023010
15	44	34x1/8"	18	1023015
20	54	44x1/6"	20	1023020
25	63	52x1/6"	21	1023025
32	70	58x1/6"	21	1023032
40	78	65x1/6"	21	1023040
50	92	78x1/6"	22	1023050
65	112	95x1/6"	25	1023065
80	127	110x1/4"	29	1023080
100	148	130x1/4"	31	1023100
125	178	160x1/4"	35	1023125
150	210	190x1/4"	40	1023150

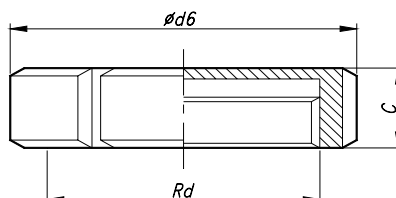

Fig.1023

TUERCA CIEGA CON PIVOTE
BLIND NUT WITH BOSS
ECROU BOUC. AVEC PIVOT

DN	Rd	d6	A	C	AISI 304L
10	28x1/8"	38	25	18	1024010
15	34x1/8"	44	25	18	1024015
20	44x1/6"	54	27	20	1024020
25	52x1/6"	63	28	21	1024025
32	58x1/6"	70	28	21	1024032
40	65x1/6"	78	28	21	1024040
50	78x1/6"	92	29	22	1024050
65	95x1/6"	112	32	25	1024065
80	110x1/4"	127	36	29	1024080
100	130x1/4"	148	38	31	1024100
125	160x1/4"	178	42	35	1024125
150	190x1/4"	210	47	40	1024150

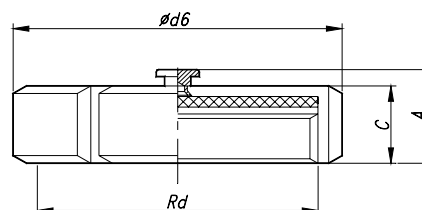

Fig.1024

TUERCA CIEGA COMPLETA
BLIND NUT COMPLET
ECROU BOUCHON AVEC PIVOT ET CHAINETTE

DN	d6	Rd	C	AISI 304L	Cadena AISI 304L
10	38	28x1/8"	18	1025010	1027010
15	44	34x1/8"	18	1025015	1027015
20	54	44x1/6"	20	1025020	1027020
25	63	52x1/6"	21	1025025	1027025
32	70	58x1/6"	21	1025032	1027032
40	78	65x1/6"	21	1025040	1027040
50	92	78x1/6"	22	1025050	1027050
65	112	95x1/6"	25	1025065	1027065
80	127	110x1/4"	29	1025080	1027080
100	148	130x1/4"	31	1025100	1027100
125	178	160x1/4"	35	1025125	1027125
150	210	190x1/4"	40	1025150	1027150

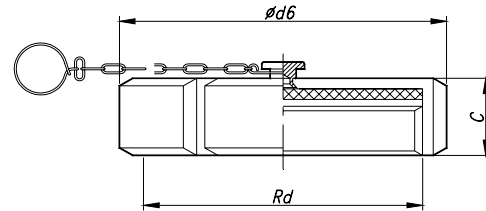

Fig.1025

MACHO MANDRINAR
EXPANDING MALE
NEZ FILETE À DUDGEONNER

DN	d1	d2	A	C	Rd	AISI 304L	AISI 316L
10	12,2	18	12	21	28x1/8"	1001010	21001010
15	18,2	24	12	21	34x1/8"	1001015	21001015
20	22,2	30	12	24	44x1/6"	1001020	21001020
25	28,2	35	15	29	52x1/6"	1001025	21001025
32	34,2	41	18	32	58x1/6"	1001032	21001032
40	40,2	48	20	33	65x1/6"	1001040	21001040
50	52,2	61	22	35	78x1/6"	1001050	21001050
65	70,3	79	25	40	95x1/6"	1001065	21001065
80	85,3	93	28	45	110x1/4"	1001080	21001080
100	104,3	114	35	54	130x1/4"	1001100	21001100
125	129,4	137	10	46	160x1/4"	1001125*	21001125
150	154,4	163	12	50	190x1/4"	1001150*	21001150

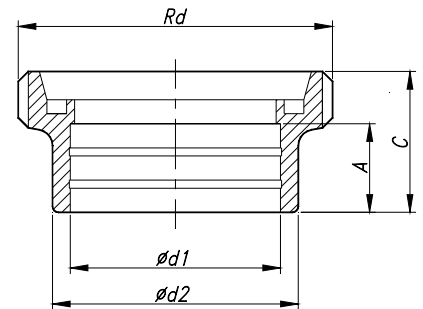

Fig.1001

- Consultar disponibilidad.
- To consult availability.
- Consulter disponibilité.

CASQUILLO MANDRINAR
EXPANDING LINER
DOUILLE À DUDGEONNER

DN	d1	d2	d6	A	C	AISI 304L	AISI 316L
10	12,2	18	22,5	12	17	1002010	21002010
15	18,2	24	28,5	12	17	1002015	21002015
20	22,2	30	36,5	12	18	1002020	21002020
25	28,2	35	44	15	22	1002025	21002025
32	34,2	41	50	18	25	1002032	21002032
40	40,2	48	56	20	26	1002040	21002040
50	52,2	61	68	22	28	1002050	21002050
65	70,3	79	86	25	32	1002065	21002065
80	85,3	93	100	28	37	1002080	21002080
100	104,3	114	121	35	44	1002100	21002100
125	129,4	137	150	10	34	1002125*	21002125
150	154,4	163	176	12	37	1002150*	21002150

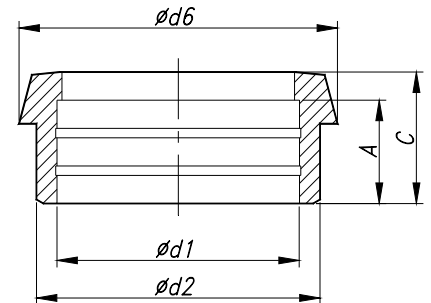

Fig.1002

- Consultar disponibilidad.
- To consult availability.
- Consulter disponibilité.

CASQUILLO CIEGO DIN
BLIND LINER DIN
BOUCHON DIN

DN	d6	d1	g	h	AISI 316L
10	22	18	6	9	21032010
15	28	24	6	9	21032015
20	36	30	8	11	21032020
25	44	35	10	13	21032025
32	50	41	10	13	21032032
40	56	48	10	13	21032040
50	68,5	61	11	14	21032050
65	86	79	12	16	21032065
80	100	93	12	16	21032080
100	121	114	15	20	210320100
125	150	137	17	22	210320125
150	176	163	18	24	210320150

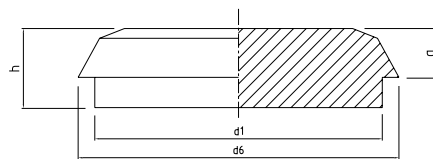

Fig.1032

- Consultar disponibilidad.
- To consult availability.
- Consulter disponibilité.

JUNTA RACORD
UNION SEAL
JOINT RACCORD

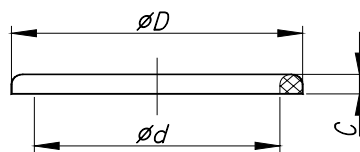

Fig.1008

DN	ϕD	$\phi d1$	C	MVQ	FPM	NBR	EPDM	PTFE
10	20	12	4	1004010	1006010	1007010	1008010	1010010
15	26	18	4	1004015	1006015	1007015	1008015	1010015
20	33	23	4	1004020	1006020	1007020	1008020	1010020
25	40	30	5	1004025	1006025	1007025	1008025	1010025
32	46	36	5	1004032	1006032	1007032	1008032	1010032
40	52	42	5	1004040	1006040	1007040	1008040	1010040
50	64	54	5	1004050	1006050	1007050	1008050	1010050
65	81	71	5	1004065	1006065	1007065	1008065	1010065
80	95	85	5	1004080	1006080	1007080	1008080	1010080
100	114	104	5	1004100	1006100	1007100	1008100	1010100
125	142	130	7	1004125	1006125	1007125	1008125	1010125
150	167	155	7	1004150	1006150	1007150	1008150	1010150

JUNTA PLANA TUERCA CIEGA
NUT SEAL
JOINT PLAT ECROU BOUCH.

DN	ϕD	MVQ	FPM	NBR	EPDM
10	28	1026010	1028010	1029010	1029010E
15	34	1026015	1028015	1029015	1029015E
20	44	1026020	1028020	1029020	1029020E
25	52	1026025	1028025	1029025	1029025E
32	58	1026032	1028032	1029032	1029032E
40	65	1026040	1028040	1029040	1029040E
50	78	1026050	1028050	1029050	1029050E
65	95	1026065	1028065	1029065	1029065E
80	110	1026080	1028080	1029080	1029080E
100	130	1026100	1028100	1029100	1029100E
125	160	1026125	1028125	1029125	1029125E
150	190	1026150	1028150	1029150	1029150E

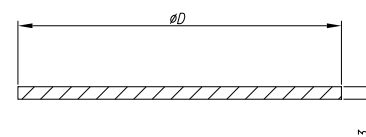

Fig.1029

JUNTA RACORD CON LABIO
 UNION SEAL WITH LIP
 JOINT RACCORD AVEC LÈVRE

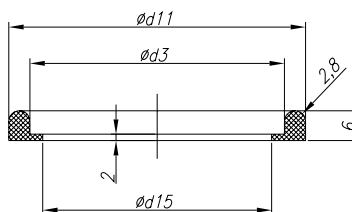

Fig.1008L

DN	$\phi d3$	$\phi d11$	$\phi d15$	NBR	EPDM	FPM	PTFE	MVQ
25	30	40	26,5	1007025L	1008025L	1006025L	1010025L	1004025L
32	36	46	32,5	1007032L	1008032L	1006032L	1010032L	1004032L
40	42	52	38,5	1007040L	1008040L	1006040L	1010040L	1004040L
50	54	64	50,5	1007050L	1008050L	1006050L	1010050L	1004050L
65	71	81	66,5	1007065L	1008065L	1006065L	1010065L	1004065L
80	85	95	81,5	1007080L	1008080L	1006080L	1010080L	1004080L
100	104	114	100,5	1007100L	1008100L	1006100L	1010100L	1004100L
125	130	142	125	1007125L	1008125L	1006125L	1010125L	1004125L
150	155	167	150	1007150L	1008150L	1006150L	1010150L	1004150L